

# Comatrol

RESPONSIVENESS IN MOTION

Member of the Danfoss Group

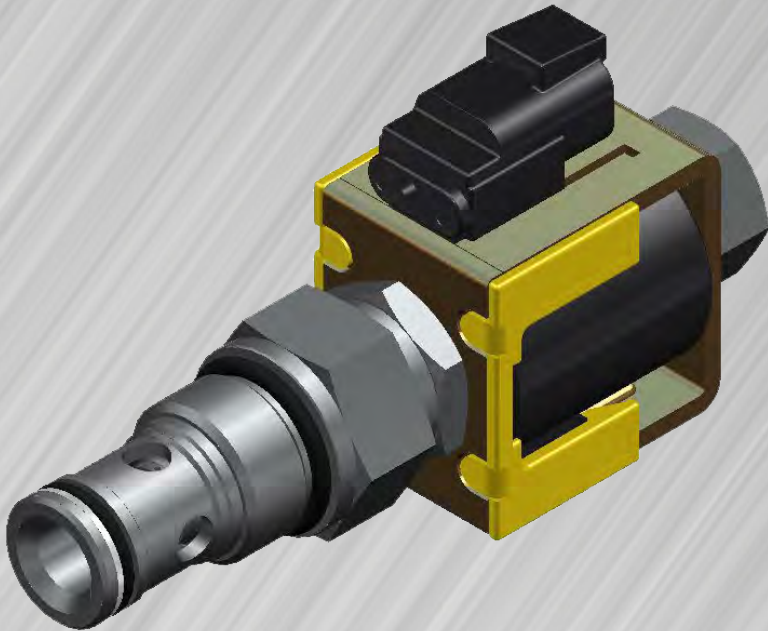

## Your Most Responsive Partner for Control Solutions

Check Valves	4	Solenoid Valves	14
Shuttle Valves	5	Proportional Valves	16
Relief Valves	5	Fan Drives	19
Pressure Reducing Valves	6	Motor Mount HICs	20
Sequence Valves	7	Traction Control HICs	21
Flow Control Valves	8	Accessories	21
Pilot Operated Check Valves	9	Spreader Valves	21
Counterbalance Valves	10	Mix-N-Match Dual Bodies	22
Directional Control Valves	11	DCV03 & DCV05 Valves	22
Logic Elements	13	Cavities & Coils	23

Visit [www.comatrol.com](http://www.comatrol.com) to locate a distributor near you.

Spring 2014

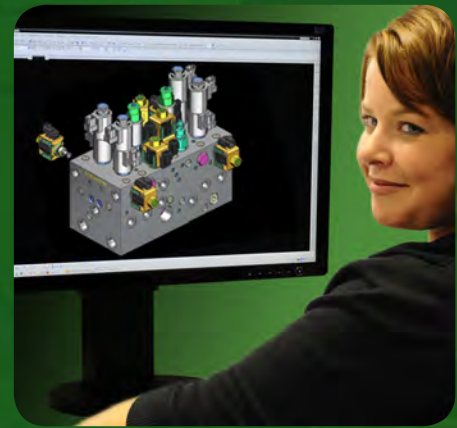

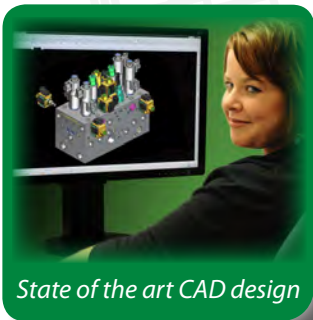

State of the art CAD design



HIC Solid Models



Custom HICs



Fan Drive HICs



## About Us

Comatrol, a member of the Danfoss Group, is the most responsive and innovative choice for Cartridge Valves and Hydraulic Integrated Circuit (HIC) needs. Comatrol works with customers and suppliers around the world to manufacture high performance machine control solutions for mobile, on-highway, energy and industrial equipment markets.

The Cartridge Valve line consists of a strong portfolio of proportional, solenoid and mechanical valves. Comatrol provides pre-engineered customer solutions with Catalog HICs, including Cross-Port Reliefs, Dual Counterbalance, Motor Mount and the new family of Fan Drive HICs.

Comatrol specializes in Custom HICs allowing customers to use our broad portfolio of cartridge valves to create innovative solutions for optimal machine control and performance.

## Our History

Originally a pioneering brand in the European cartridge valve market, Comatrol is a global business built on the strength of our experience and established position within the fluid controls industry. At Comatrol, product focus means product expertise, allowing us to be the market leader in HIC design and prototype speed. Our comprehensive cartridge portfolio brought together by Danfoss, combines three separate product lines allowing customers to buy the best individual components at competitive prices straight from the source.

## Our Experience

Comatrol represents a long history of experience and an established position within the fluid controls industry. Since 1980, we have built upon the knowledge and expertise within the design, application and manufacturing of cartridge valves and HICs to become the preferred component provider for over 1800 companies and distributors throughout the world. Our leadership and engineering team have over 300 years combined fluid power experience and in the words of one of our account managers, "This is all we do and we do it well!"



## Our Products

As a market leader in HIC design, Comatrol has built upon our engineering and application expertise to create a balanced offering with over 500 high quality catalog products including configurable cartridge valves and Catalog HICs to meet your control solutions needs.

## Operational Excellence

Responsiveness resonates throughout every aspect of Comatrol's business. Our aim is to link your request to the supplier network in order to compress lead time and improve quality, providing the most valuable control solutions on the market today. Comatrol's ISO 9001-2008 certified facilities help ensure the delivery of high quality precision products at world class levels.



Motor Mount HICs



Valve Hybrid HICs



HICs with steering unit

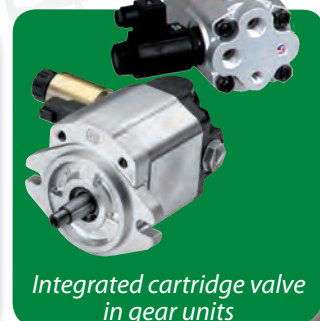

Integrated cartridge valve in gear units



## EasyValve®

EasyValve – where custom HIC solutions and creativity meet

Our flagship design software EasyValve is the e-destination that takes custom HIC solutions to the next level by providing a streamlined development process from the customer to the Comatrol engineer.

EasyValve's intuitive user interface allows you to proficiently create your hydraulic circuit schematic by simply dragging and dropping from Comatrol's complete digital library of cartridge valves, Cetop valves and accessories. Capture your technical, commercial and application requirements to accurately document and communicate your custom HIC needs - allowing you to get exactly what you want from the first drawing, reducing the prototype cycle time by as much as half.

## Features

- Quickly select the products, ports and machining options you need by navigating the library, or by using the search function – then drag and drop onto your Schematic Layout
- Easily configure all of your selected items to meet your application needs with the drop-down component selection functionality
- To help make optimal technical vs. pricing\* decisions, this information is now readily available in one location on the Component Specification page of each item, which also includes the valve catalog pages
- The Project Information View allows you to capture customer, technical, and HIC material information
- The Manifold Layout page allows you to capture customer-critical layout information where you can define the maximum envelope dimensions and the location of valves, ports and mounting holes
- Outputs Include:
  - o Project file that stores all your work into one document [.HICS]
  - o Project Summary
  - o Schematic in DXF format
  - o Automation Studio™ output [.HIX] to support your simulation needs
- The Project Summary includes:
  - o Customer and Distributor Information
  - o Net price\* and other Commercial Information
  - o Technical Parameters
  - o Schematic
  - o Manifold Layout
  - o Bill of Material
  - o Warnings and Revision History

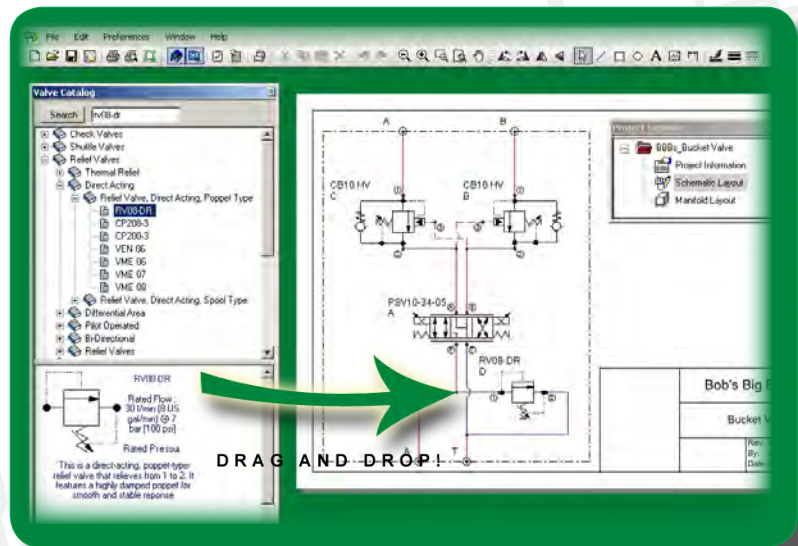

Schematic Layout - Drag and Drop from Library

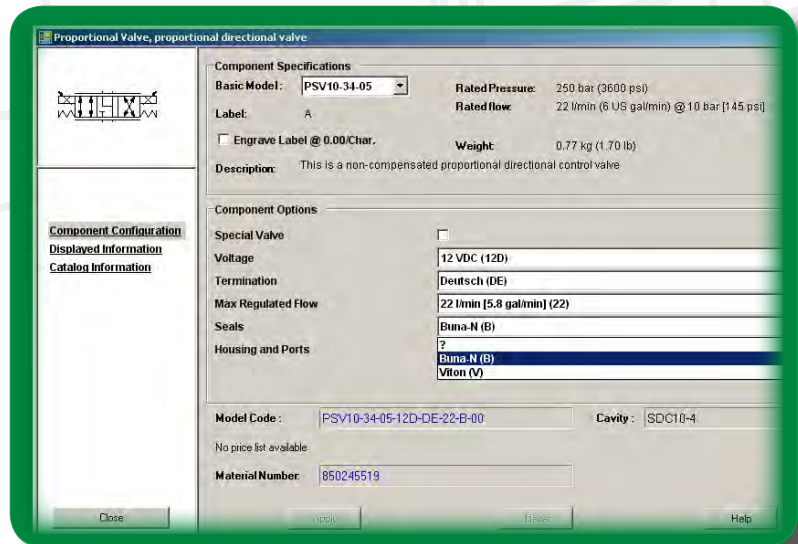





Component Specifications - Configuring Products

From inception to installation, EasyValve ensures that the first prototype is the right prototype. Download EasyValve software and see for yourself what responsiveness in motion looks like firsthand.

\*Pricing is only available to Comatrol distributors



## Check Valves - Threaded

SCHEMATIC / DESCRIPTION	MODEL	BAR PSI	LPM GPM	CAVITY
 <p>Ball Type, Normal Direction</p>	CV04-NB	207 3000	3 0.9	CP04-2
	CV08-NB	207 3000	30 8	SDC08-2
	CV10-NB	207 3000	83 22	SDC10-2
 <p>Poppet Type, Normal Direction</p>	CV08-NP	310 4500	30 8	SDC08-2
	CV10-NP	300 4350	85 22	SDC10-2
	CP100-3	<b>350</b> <b>5075</b>	115 30	SDC10-2
	CP102-1	210 3000	210 55	SDC16-2
	CP103-1	210 3000	380 100	SDC20-2
 <p>Reverse Direction, No Spring</p>	CP104-2	<b>350</b> <b>5075</b>	3 .8	CP04-2
 <p>Reverse Direction</p>	CP108-2	<b>350</b> <b>5075</b>	20 5	SDC08-2
	CP100-2	<b>350</b> <b>5075</b>	50 13	SDC10-2
	CP101-2	<b>350</b> <b>5075</b>	75 20	CP12-2
	CP102-2	<b>350</b> <b>5075</b>	150 40	SDC16-2
	CP103-2	<b>350</b> <b>5075</b>	265 70	SDC20-2

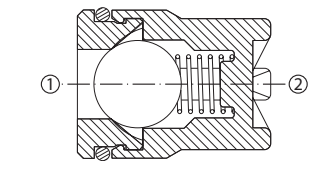
## Check Valves - Slip-In

SCHEMATIC / DESCRIPTION	MODEL	BAR PSI	LPM GPM	CAVITY
  <p>Slip-In</p>	3C50-01	210 300	70 19	FC-144
	3C60-01	140 2000	7 19	FC-144
	3C80-01	140 2000	190 50	FC-304
	3C90-01	210 3000	190 50	FC-304

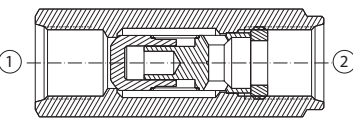
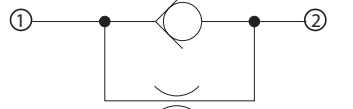
## Check Valves - In-line

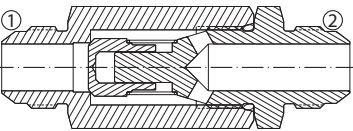
SCHEMATIC / DESCRIPTION	MODEL	BAR PSI	LPM GPM	PORTS
  <p>In-line, Female Port</p>	3C11-01	<b>350</b> <b>5075</b>	20 5	#4 SAE
	RS 06	<b>350</b> <b>5075</b>	30 8	#6 SAE 1/4 BSP
	3C12-01	<b>350</b> <b>5075</b>	35 9	#6 SAE
	RS 10	<b>350</b> <b>5075</b>	60 16	3/8 BSP
	3C13-01	<b>350</b> <b>5075</b>	70 19	#8 SAE
	3C14-01	<b>350</b> <b>5075</b>	95 25	#12 SAE
	RS 13	315 4500	100 26	1/2 BSP
	RS 19	280 4000	140 37	#12 SAE 3/4 BSP
	3C15-01	<b>350</b> <b>5075</b>	150 40	#16 SAE
	RS 25	245 3500	200 53	#16 SAE 1 BSP
3C16-01	<b>350</b> <b>5075</b>	230 61	#20 SAE	
 <p>In-line, Female Port, with Orifice</p>	2RN11-01	<b>350</b> <b>5075</b>	20 5	#4 SAE
  <p>In-line, Male Port</p>	3CM11-01	<b>350</b> <b>5075</b>	20 5	#6 SAE
	3CM12-01	<b>350</b> <b>5075</b>	35 9	#8 SAE
	3CM15-01	<b>350</b> <b>5075</b>	150 40	#16 SAE

## Shuttle Valves - Load Shuttle

SCHEMATIC / DESCRIPTION	MODEL	BAR PSI	LPM GPM	CAVITY
<p>Normal Direction</p>	CP124-1	<b>350</b> 5075	4 1	CP04-3
	CP128-1	210 3000	10 3	SDC08-3
	SV 04	315 4500	15 4	NCS04/3
	CP120-4	330 4800	25 7	SDC10-3
	SV 06	315 4500	60 16	NCS06/3
<p>In-line</p>	VS 06	<b>350</b> 5075	35 9	1/4 BSP Port
	VS 10	<b>350</b> 5075	45 12	3/8 BSP Port

## Relief Valves - Direct Acting

SCHEMATIC / DESCRIPTION	MODEL	BAR PSI	LPM GPM	CAVITY
<p>Thermal Relief, Direct Acting, Poppet Type</p>	CP208-4	<b>415</b> 6000	1.1 .3	SDC08-2
<p>Direct Acting, Poppet Type</p>	CP208-3	250 3600	30 8	SDC08-2
	CP200-3	250 3600	40 11	SDC10-2
<p>Direct Acting, Damping, Poppet Type</p>	RV08-DR	250 3600	30 8	SDC08-2
	VEN 06	250 3600	40 11	NCS06/2
	VME 06	315 4000	40 11	VME 06
	VME 07	315 4000	50 13	VME 07
<p>Direct Acting, Spool Type</p>	CP210-1	210 3000	45 12	SDC10-2
	CP211-1	40 600	75 20	CP12-2

## Shuttle Valves - Hot Oil

SCHEMATIC / DESCRIPTION	MODEL	BAR PSI	LPM GPM	CAVITY
<p>Hot Oil Shuttle</p>	CP720-3	<b>350</b> 5075	25 7	SDC10-4
<p>Hot Oil Shuttle</p>	CP721-3	<b>350</b> 5075	90 24	CP12-3M

**RV08-DR**  
Relief Valve



**RV10-POP**  
Relief Valve



## Relief Valves - Differential

SCHEMATIC / DESCRIPTION	MODEL	BAR PSI	LPM GPM	CAVITY
<p>Relief Valve, Differential Area, Poppet Type</p>	CP200-2	<b>350</b> 5075	40 11	SDC10-2
	CP208-1	250 3600	40 11	SDC08-2
	CP200-1	250 3600	75 20	SDC10-2
	CP201-1	250 3600	150 40	CP12-2

## Relief Valves - Differential (continued)

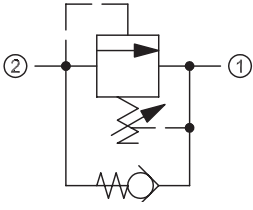
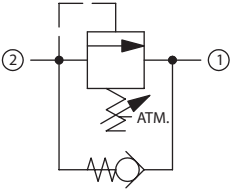
SCHEMATIC / DESCRIPTION	MODEL	BAR PSI	LPM GPM	CAVITY
 <p>Differential Area, Poppet Type with Reverse Free Flow Check</p>	VSB 06-EN	350 5075	80 21	NCS06/2
	VSB 12-EN	350 5075	140 37	NCS12/2
 <p>Differential Area, Poppet Type with Reverse Free Flow Check, Atmospheric Venting</p>	VSB 06-CN	350 5075	80 21	NCS06/2
	VSB 12-CN	350 5075	140 37	NCS12/2

## Relief Valves - Cross-Over

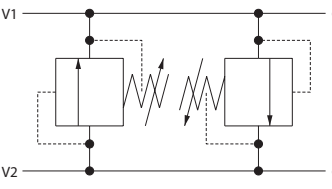
SCHEMATIC / DESCRIPTION	MODEL	BAR PSI	LPM GPM	PORTS
 <p>Cross-Over, Catalog HIC</p>	VA-E 06	210 3045	40 11	3/8 BSP
	CP220-1	250 3600	75 20	3/8 & 1/2 BSP #6 & #8 SAE
	CP221-1	250 3600	190 50	3/4 & 1 BSP #12 & #16 SAE

## Relief Valves - Pilot Operated

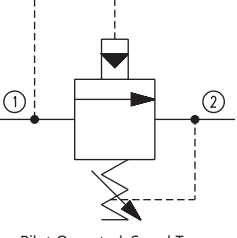
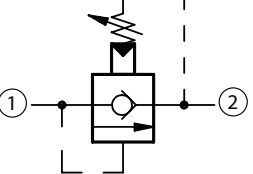
SCHEMATIC / DESCRIPTION	MODEL	BAR PSI	LPM GPM	CAVITY
 <p>Pilot Operated, Spool Type</p>	CP210-2	350 5075	115 30	SDC10-2
	CP211-2	350 5075	190 50	CP12-2
 <p>Pilot Operated, Poppet Type, Reverse Free Flow</p>	RV10-POP	250 3625	120 32	SDC10-2

## Relief Valves - Bi-Directional

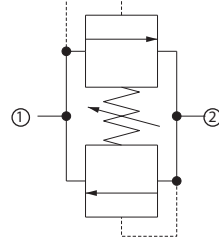
SCHEMATIC / DESCRIPTION	MODEL	BAR PSI	LPM GPM	CAVITY
 <p>Relief Valve, Bi-directional</p>	CP200-7	250 3600	40 11	SDC10-2

## Pressure Reducing Valves

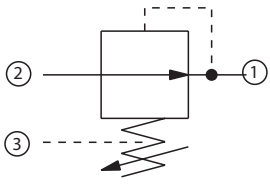
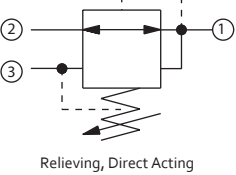
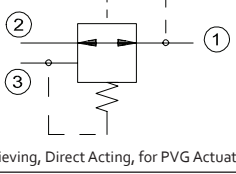
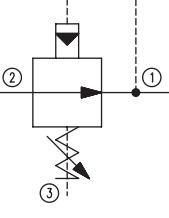
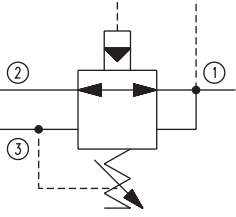
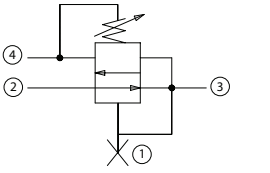

SCHEMATIC / DESCRIPTION	MODEL	BAR PSI	LPM GPM	CAVITY
 <p>Non-Relieving, Direct Acting</p>	CP230-2	210 3000	40 10	SDC10-3
 <p>Relieving, Direct Acting</p>	PRC 06	315 4500	40 10	NCS06/3
 <p>Relieving, Direct Acting, for PVG Actuators</p>	CP230-1	210 3000	40 10	SDC10-3
 <p>Non-Relieving, Pilot Operated</p>	CP230-4	350 5075	40 10	SDC10-3
	PPRC-06	315 4500	40 10	NCS06/3
 <p>Relieving, Pilot Operated</p>	PRMP 064	315 4500	40 10	SDC10-3
	CP231-3	350 5075	115 30	CP12-3S
 <p>Relieving, Direct Acting, with Damping Port</p>	PRR10-DRD	207 3000	38 10	SDC10-4

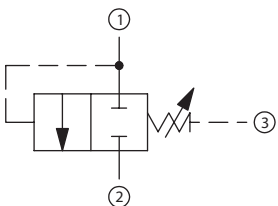
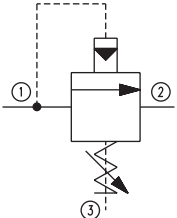
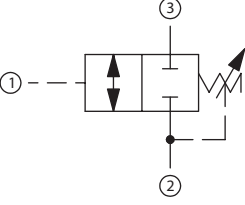
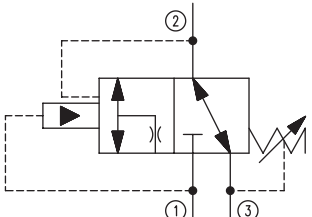
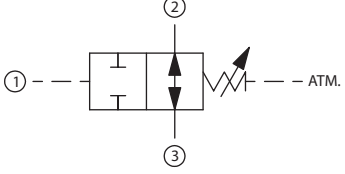
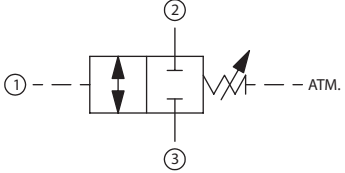
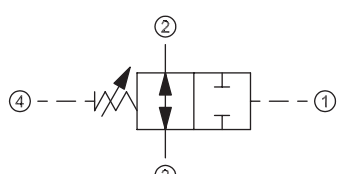
# Sequence Valves

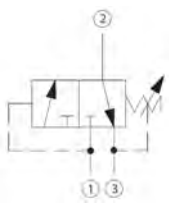
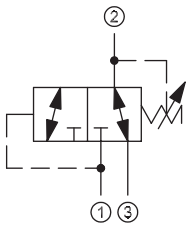
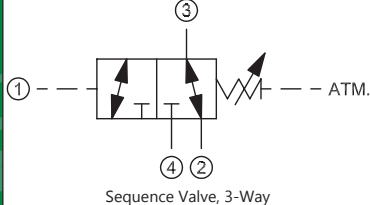
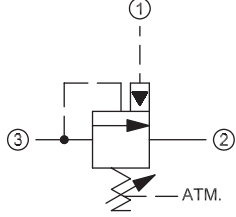
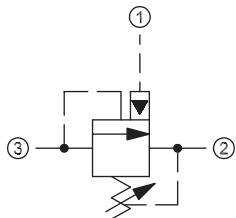
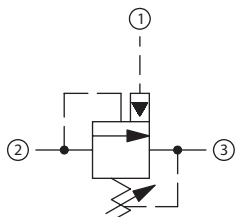
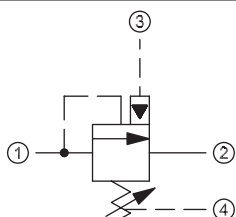
SCHEMATIC/DESCRIPTION	MODEL	BAR PSI	LPM GPM	CAVITY
 <p>Sequence Valve, 2-Way, Normally Closed</p>	CP240-8	210 3000	55 14	SDC10-3
	CP241-8	40 600	150 39	CP12-3S
 <p>Sequence Valve, Pilot Operated Spool</p>	CP240-21	350 5075	45 12	SDC10-3
	CP241-21	350 5075	75 20	CP12-3S
 <p>Sequence Valve, 2-Way, Normally Closed, External Pilot, Internal Drain</p>	CP240-2	210 3000	35 9	SDC10-3
 <p>Sequence Valve, Kick-Down Type</p>	CP240-22	350 5075	45 12	SDC10-3
 <p>Sequence Valve, 2-Way, Normally Open</p>	VDP 06/NA	315 4500	25 7	NCS06/3
 <p>Sequence Valve, 2-Way, Normally Closed</p>	VDP 06/NC	315 4000	25 7	NCS06/3
 <p>Sequence Valve, 2-Way, Normally Open</p>	CP240-5	210 3000	25 7	SDC10-4

SCHEMATIC/DESCRIPTION	MODEL	BAR PSI	LPM GPM	CAVITY
 <p>Sequence Valve, 3-Way, Internal Pilot, Internal Drain</p>	CP240-1	210 3000	25 7	SDC10-3
 <p>Sequence Valve, 3-Way</p>	CP240-9	210 3000	20 5	SDC10-3
 <p>Sequence Valve, 3-Way</p>	VDP 06/4201	315 4500	22 6	NCS06/4
 <p>Unloading Valve, Differential Area, Pilot Operated, Atmospheric Vent</p>	VDB 06-CN	350 5075	80 21	NCS06/3
 <p>Unloading Valve, Differential Area, Pilot Operated</p>	VDB 06-EN	350 5075	80 21	NCS06/3
	VDB 12-EN	350 5075	160 42	NCS12/3
 <p>Unloading Valve, Pilot Operated</p>	CP240-30	240 3500	4 1	SDC10-3
 <p>Unloading Valve, Pilot Operated, Spool</p>	AUV 06	250 3600	50 13	NCS06/4

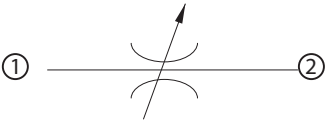
## Flow Control Valves - Needle Valves

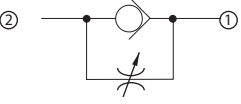
SCHEMATIC/DESCRIPTION	MODEL	BAR PSI	LPM GPM	CAVITY
 <p>Needle Valve, Bi-Directional, Fine Metering</p>	CP618-6	310 4500	10 3	SDC08-2
 <p>Needle Valve, Bi-Directional</p>	CP618-1	210 3000	25 7	SDC08-2
	CP618-2	210 3000	45 12	SDC08-2
	CP610-1	210 3000	50 13	SDC10-2
	CP610-2	210 3000	50 13	SDC10-2
	CP611-2	210 3000	115 30	CP12-2
	CP612-1	210 3000	190 50	SDC16-2
	CP612-2	210 3000	190 50	SDC16-2
	CP613-1	210 3000	380 100	SDC20-2
 <p>Needle Valve, Bi-Directional, Fine Metering, Rev. Free Flow</p>	CP610-7	210 3000	55 15	SDC10-2

## Flow Control Valves - Pressure Compensated

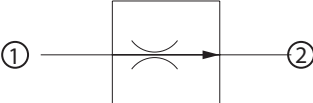
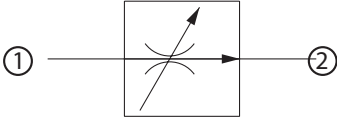
SCHEMATIC/DESCRIPTION	MODEL	BAR PSI	LPM GPM	CAVITY
 <p>Flow Control Valve, Fixed Setting, Restrictive Type</p>	CP308-1	210 3000	15 4	SDC08-2
 <p>Flow Control Valve, Adjustable, Restrictive Type</p>	CP300-1	210 3000	23 6	SDC10-2
	CP301-1	210 3000	57 15	CP12-2
	CP308-2	210 3000	15 4	SDC08-2
	CP300-2	210 3000	23 6	SDC10-2
	VR 06	315 4500	30 8	NCS06/2
	VR 12	315 4500	60 16	NCS12/2

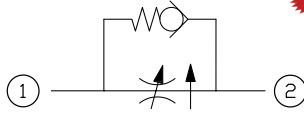
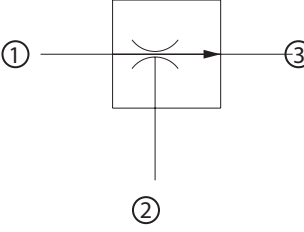
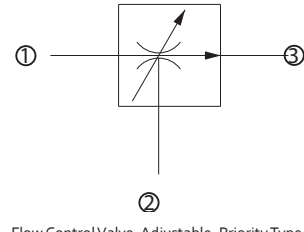
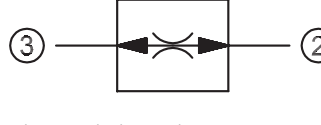
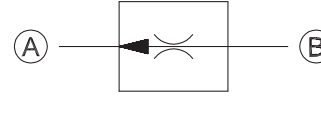
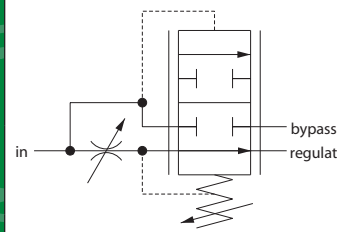
SCHEMATIC/DESCRIPTION	MODEL	BAR PSI	LPM GPM	CAVITY
 <p>High Pressure Flow Control, Variable Orifice, Restrictive Type</p>	HFCV10-RT	350 5075	11.4 (3.0)	SDC10-2
 <p>Flow Control Valve, Fixed Setting, Priority Type</p>	CP310-1	210 3000	23 6	SDC10-3
	VRF 06	315 4500	30 8	NCS06/3
	CP311-1	210 3000	45 12	CP12-3
	CP312-1	210 3000	65 17	SDC16-3
 <p>Flow Control Valve, Adjustable, Priority Type</p>	CP310-2	210 3000	23 6	SDC10-3
	VRC 06	315 4500	50 13	NCS06/3
	VRC 12	315 4500	100 26	NCS12/3
 <p>Flow Control Valve, Fixed Setting, Bi-Directional</p>	CP300-6	210 3000	23 6	SDC10-3
	FCH10-BD	350 5075	23 6	SDC10-3
 <p>Flow Control Valve, In-line</p>	SC 10	210 3000	16 4	3/8 BSP Ports
	SC 13	210 3000	47 12	1/2 BSP Ports
 <p>Flow Control Valve, Adjustable, Priority Type ,Catalog HIC</p>	2F94-01	210 3000	30 8	#6 SAE Ports
	2F95-01	210 3000	60 16	#8 SAE Ports
	2F96-01	210 3000	95 25	#12 SAE Ports
	2F97-01	210 3000	190 50	#16 SAE Ports

Pressure Compensators - See Logic Elements



**HFCV10-RT**  
Flow Control Valve

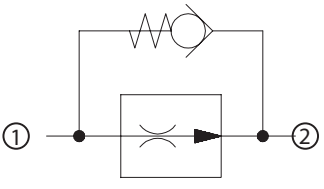

## Flow Control Valves - Load Lowering

SCHEMATIC/DESCRIPTION	MODEL	BAR PSI	LPM GPM	CAVITY
 <p>Load Lowering Valve</p>	CP9014-1	210 3000	113 30	Modified #14 SAE Cavity #10 & #12 SAE Ports

## Pilot Operated Check Valves

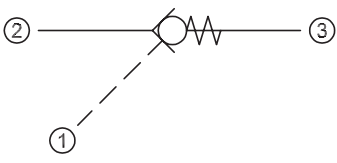
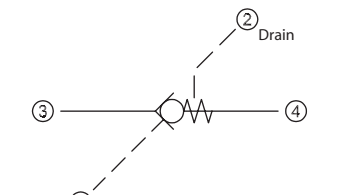
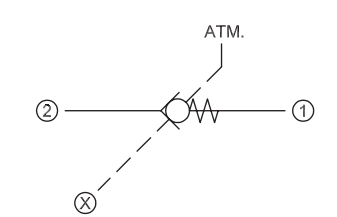
SCHEMATIC/DESCRIPTION	MODEL	BAR PSI	LPM GPM	CAVITY
 <p>Pilot Operated Check Valve, Pilot to Open</p>	RPC 04	210 3000	12 3	NCS04/3
	RPC 06	315 4500	25 7	NCS06/3
	CP450-1	240 3480	30 8	SDC10-3
	RPC 12	315 4500	70 18	NCS12/3
	CP458-2	210 3000	20 5	SDC08-3
	MC10-RO	210 3000	45 12	SDC10-3S
	CP451-2	210 3000	95 25	CP12-3S
	CP452-2	210 3000	130 34	SDC16-3S
	CP453-2	210 3000	230 61	CP20-3S
 <p>Pilot Operated Check Valve, Reverse Pilot to Open</p>	RPV 06	315 4500	30 8	NCS06/4
 <p>Pilot Operated Check Valve, Reverse Pilot-to-open with vent</p>	CP453-5	350 5075	250 66	SDC20-2
	CP460-1	210 3000	45 12	SDC10-3
	CP461-1	210 3000	115 30	CP12-3S
	CP462-1	210 3000	190 50	SDC16-3S

## Velocity Fuses

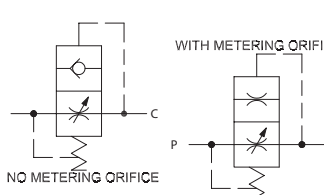
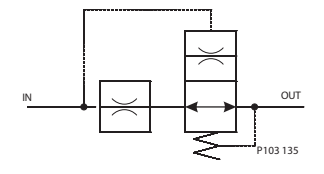
SCHEMATIC/DESCRIPTION	MODEL	BAR PSI	LPM GPM	PORTS
 <p>Velocity Fuse</p>	BC 06	210 3000	30 8	1/4 BSP
	BC 10	210 3000	60 16	3/8 BSP
	BC 13	210 3000	85 22	1/2 BSP
 <p>Velocity Fuse</p>	CP330-3	207 3000	110 29	#10 SAE

## Flow Control Valves - Flow Dividers

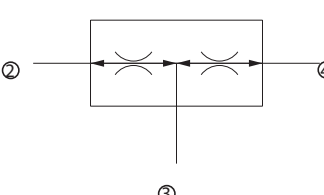
SCHEMATIC/DESCRIPTION	MODEL	BAR PSI	LPM GPM	CAVITY
 <p>Flow Divider, Divider/Combiner</p>	CP340-1	210 3000	45 12	SDC10-4
	VDF 06	210 3000	45 12	NCS06/4
	CP341-1	210 3000	75 20	CP12-4
	CP342-1	210 3000	150 40	CP16-4
	CP342-3	450 6500	150 40	CP16-4
	CP343-1	210 3000	340 90	SDC20-4

## Pilot Operated Check Valves - (continued)

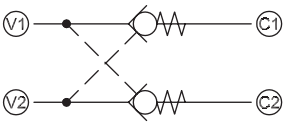
SCHEMATIC/DESCRIPTION	MODEL	BAR PSI	LPM GPM	CAVITY
 <p>Pilot Operated Check Valve, Catalog HIC</p>	CP410-1	210 3000	85 22	3/8 & 1/2 BSP #6 & #8 SAE

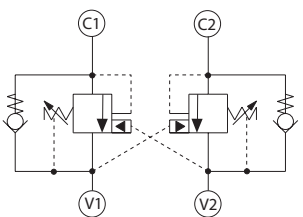
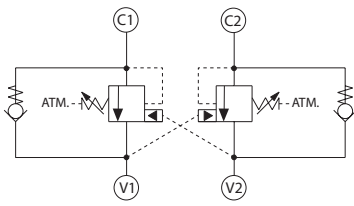
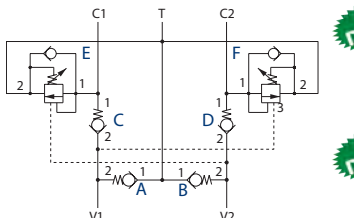
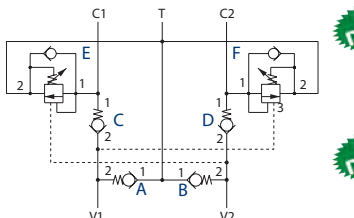
SCHEMATIC/DESCRIPTION	MODEL [FORMER]	BAR PSI	LPM GPM	CAVITY
 <p>Dual Counterbalance Valve, Hydraulic Vent, Catalog HIC</p>	CP448-2	350 5075	20 5	#4 & 6 SAE 3/8 BSP
	VCB06-EN-DL	350 5075	60 16	#6 & 8 SAE 3/8 & 1/2 BSP
	DCB10-HV	350 5075	60 16	#6 & 8 SAE 3/8 & 1/2 BSP
	CP441-2	350 5075	115 30	#10,12 SAE 1/2 & 3/4 BSP
	VCB12-EN-DL	350 5075	140 37	#8, 12 SAE 1/2 & 3/4 BSP
 <p>Dual Counterbalance, Atmospheric Vent, Cat. HIC</p>	DCB10-AV	350 5075	60 16	#6 & 8 SAE 3/8 & 1/2 BSP
 <p>Dual-Counterbalance w/ Makeup Checks, Cat. HIC</p>	VCB06-CN-DL	350 5075	60 16	#6 & 8 SAE 3/8 & 1/2 BSP
	VCB12-CN-DL	350 5075	140 37	#8, 12 SAE 1/2 & 3/4 BSP
 <p>Dual-Counterbalance w/ Makeup Checks, Cat. HIC</p>	DCB10-MC [1EEC11-01]	350 5075	57 15	#6 SAE & #8 SAE Ports
	DCB12-MC [1EEC12-01]	350 5075	95 25	3/4 BSP #10 & #12 SAE

## Counterbalance Valves

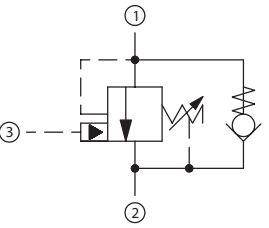
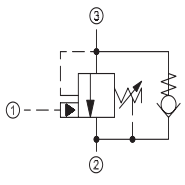
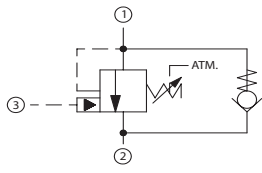
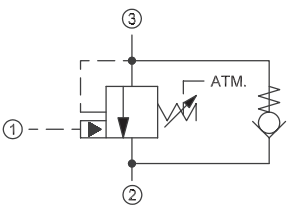
SCHEMATIC/DESCRIPTION	MODEL [FORMER]	BAR PSI	LPM GPM	CAVITY
 <p>Counterbalance Valve, Hydraulic Vent</p>	CP448-1	350 5075	20 5	CP08-3L
	CB10-HV	350 5075	60 16	SDC10-3S
	CP441-1	350 5075	115 30	CP12-3S
	CB20-HV [CP443-1]	345 5000	266 70	CP20-3S
 <p>Counterbalance Valve, Hydraulic Vent, Pilot Port 1</p>	VCB06-EN	350 5075	60 16	NCS06-3
	VCB 12-EN	350 5075	140 37	NCS12-3
 <p>Counterbalance Valve, Atmospheric Vent</p>	CB10-AV	350 5075	60 16	SDC10-3S
	VCB06-CN	350 5075	60 16	NCS06-3
 <p>Counterbalance Valve, Atmospheric Vent, Pilot Port 1</p>	VCB12-CN	350 5075	140 37	NCS12-3



Counterbalance Valves

VCB-DL Dual Counterbalance Nose to Nose Design

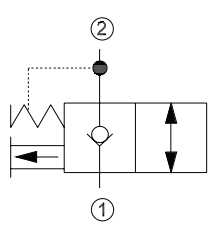
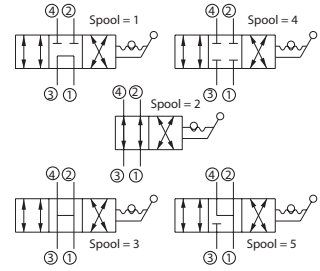
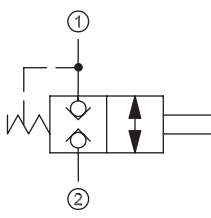
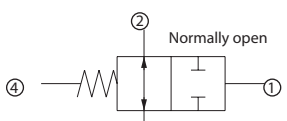
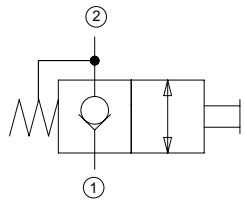
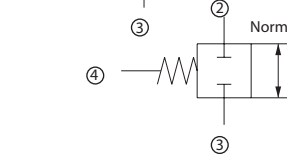
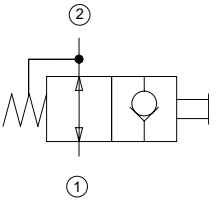
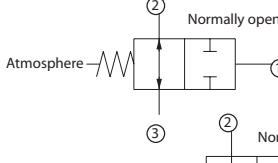
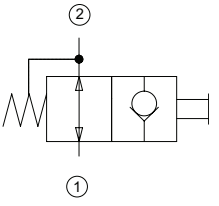
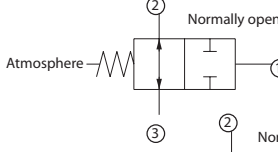
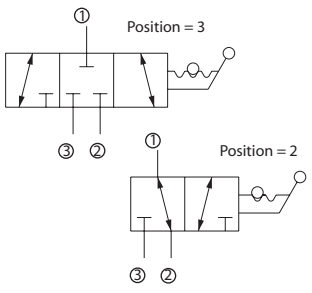
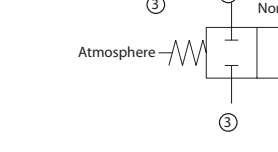
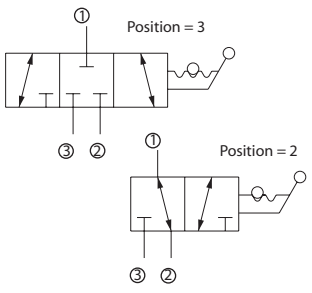
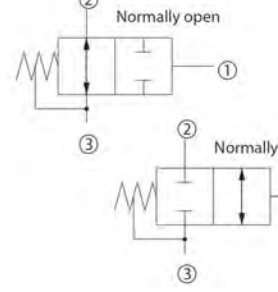
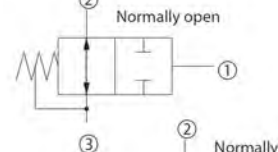
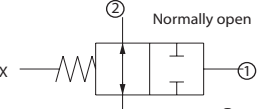

# Directional Control Valves

SCHEMATIC/DESCRIPTION	MODEL	BAR PSI	LPM GPM	CAVITY	SCHEMATIC/DESCRIPTION	MODEL	BAR PSI	LPM GPM	CAVITY
 <p>Directional Mechanical, Poppet, Pull to Open</p>	CP600-1	210 3000	68 18	SDC10-2	 <p>Directional Manual, Rotary, 2-Position, 4-Way</p>	CP640-1	210 3000	10 3	SDC10-4
 <p>Directional Mechanical, Poppet, Pull to Open</p>	CE 06	210 3000	20 5	NCS06/2	 <p>Directional Control Valve, 2-Position, 2-Way</p>	CP710-8	210 3000	40 11	SDC10-4
 <p>Directional Mechanical, Poppet, Normally Closed</p>	DMP08-NC	210 3000	38 10	SDC08-2	 <p>Directional Control Valve, 2-Position, 2-Way</p>	CP712-11	450 6500	130 34	CP16-4
 <p>Directional Mechanical, Poppet, Normally Open</p>	DMP08-NO	210 3000	38 10	SDC08-2	 <p>Directional Control Valve, 2-Position, 2-Way, Atmospheric Vent</p>	CP712-8	210 3000	130 34	CP16-4
 <p>Directional Manual, Rotary, 2-Position, 2-Way</p>	CP620-1	210 3000	75 20	SDC10-2	 <p>Directional Control Valve, 2-Position, 2-Way, Atmospheric Vent</p>	CP710-1	210 3000	40 11	SDC10-3
 <p>Directional Manual, Rotary, 2-Position, 3-Way</p>	CP630-1	210 3000	30 8	SDC10-3	 <p>Directional Control Valve, 2-Position, 2-Way, Atmospheric Vent</p>	CP712-1	210 3000	130 34	SDC16-3
					 <p>Directional Control Valve, 2-Pos., 2-Way, Hydraulic Vent</p>	CP710-3	210 3000	40 11	SDC10-3
					 <p>Directional Control Valve, 2-Position, 2-Way, External Pilot</p>	CP710-2	210 3000	40 11	SDC10-3
					 <p>Directional Control Valve, 2-Position, 2-Way, External Pilot</p>	CP712-2	210 3000	130 34	SDC16-3
					 <p>Directional Control Valve, 2-Position, 2-Way, External Pilot</p>	CP713-2	210 3000	265 70	SDC20-3

# Directional Control Valves (continued)

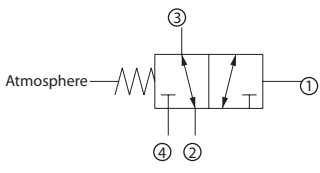
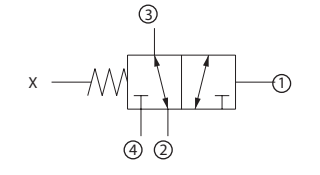
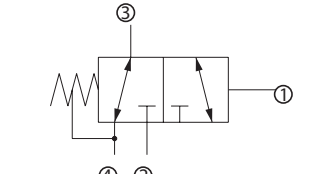
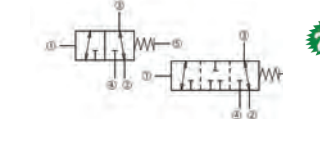
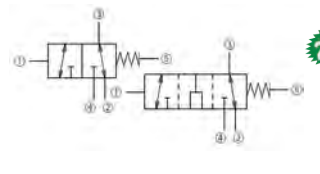
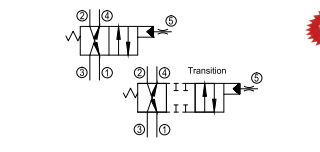
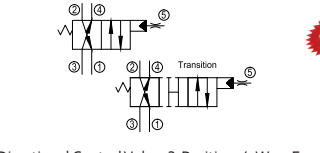
SCHEMATIC/DESCRIPTION	MODEL	BAR PSI	LPM GPM	CAVITY
 <p>Directional Control Valve, 2-Position, 3-Way, Atmospheric Vent</p>	CP720-1	210 3000	30 8	SDC10-4
	CP722-1	210 3000	130 34	CP16-4
	CP723-1	210 3000	265 70	SDC20-4
 <p>Directional Control Valves, 2-Position, 3-Way, External Pilot</p>	CP720-2	210 3000	25 7	SDC10-4
	CP722-2	210 3000	130 34	CP16-4
	CP723-2	210 3000	265 70	SDC20-4
 <p>Directional Control Valve, 2-Position, 3-Way, Hydraulic Vent</p>	CP720-5	210 3000	40 11	SDC10-4
	CP722-11	450 6500	125 33	CP16-4
	CP722-5	210 3000	130 34	CP16-4
	CP723-5	210 3000	265 70	SDC20-4
 <p>Directional Control Valve, 2-Position, 3-Way, Pilot Port 5, Closed Transition</p>	DV16-P5-23-01-CT	210 3045	130 34	SDC16-5S
 <p>Directional Control Valve, 2-Position, 3-Way, Pilot Port 5, Open Transition</p>	DV16-P5-23-01-OT	210 3045	130 34	SDC16-5S
 <p>Directional Control Valve, 2-Position, 4-Way, Pilot Port 5</p>	DV15-P5-24-01	230 3335	70 18	NCS 12/5
 <p>Directional Control Valve, 2-Position, 4-Way, Fan Drive, Pilot Port 5</p>	DV15-P5-24-FD	230 3335	70 18	NCS 12/5

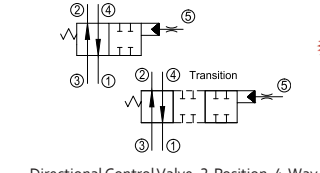
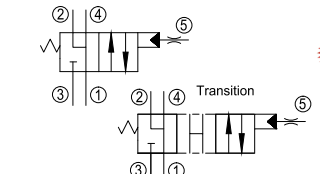
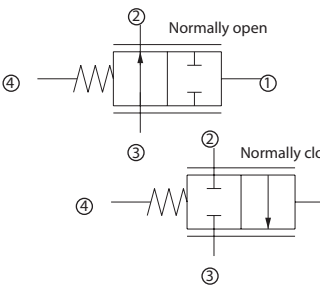
SCHEMATIC/DESCRIPTION	MODEL	BAR PSI	LPM GPM	CAVITY
 <p>Directional Control Valve, 2-Position, 4-Way, Pilot Port 5</p>	DV15-P5-24-05	230 3335	70 18	NCS 12/5
 <p>Directional Control Valve, 2-Position, 3-Way, Pilot Port 5</p>	DV15-P5-24-08	230 3335	80 21	NCS 12/5
 <p>Directional Control Valve, Normally Closed/Open, Hydraulically Piloted, Proportional</p>	CP712-7	210 3000	220 58	CP16-4

## DV15 High Flow Directional Valve

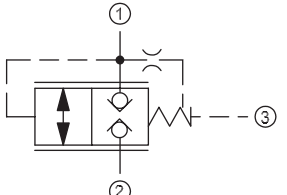
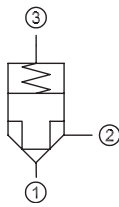
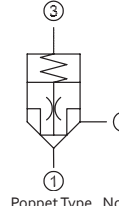
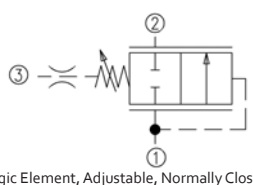
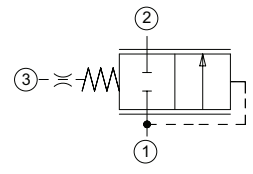
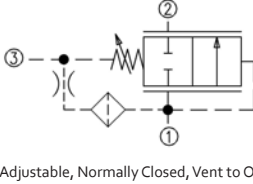
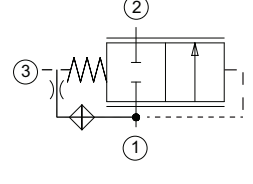

# Logic Elements/Differential Sensing Valves

SCHEMATIC/DESCRIPTION	MODEL	BAR PSI	LPM GPM	CAVITY
 Logic Element, Poppet Type, Double Blocking, Normally Closed, Vent to Open	VLP 12/P2	315 4500	160 42	NCS12/3
 Logic Element, Poppet Type, Normally Closed, Pilot to Close	VLP 12/A5	315 4500	160 42	NCS12/3
 Logic Element, Poppet Type, Normally Closed, Vent to Open	VLP 12/C2	315 4500	160 42	NCS12/3
 Logic Element, Adjustable, Normally Closed, Pilot to Close	HLEA10-CPC	350 5075	80 21	SDC10-3S
 Logic Element, Normally Closed, Pilot to Close	CP700-1	210 3000	50 13	SDC10-3
	HLE10-CPC	350 5075	80 21	SDC10-3
	CP701-1	210 3000	150 40	CP12-3S
	CP702-1	210 3000	190 50	SDC16-3S
	LE20-CPC	210 3000	320 85	CP20-3S
 LE, Adjustable, Normally Closed, Vent to Open	HLEA10-CVO	350 5075	80 21	SDC10-3S
 Logic Element, Normally Closed, Vent to Open	CP700-2	210 3000	50 13	SDC10-3
	HLE10-CVO	350 5075	80 21	SDC10-3S
	CP701-2	210 3000	150 40	CP12-3S
	CP702-2	210 3000	190 50	SDC16-3S
	CP703-2	210 3000	320 85	CP20-3S

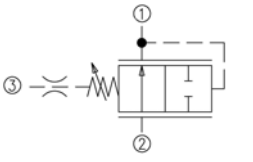
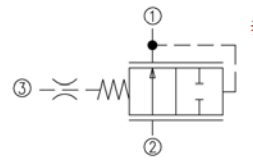
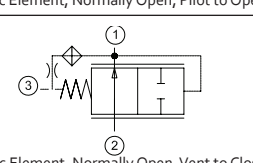
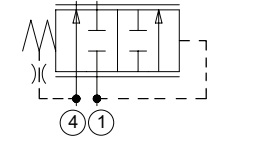
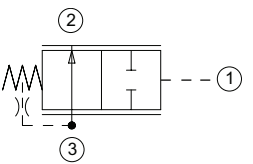
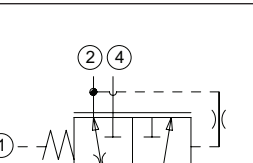
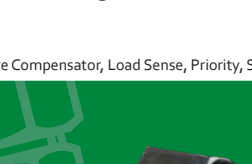
SCHEMATIC/DESCRIPTION	MODEL	BAR PSI	LPM GPM	CAVITY
 LE, Adjustable, Normally Open, Pilot to Open	HLEA10-OPO	350 5075	60 16	SDC10-3S
 Logic Element, Normally Open, Pilot to Open	CP700-4	210 3000	40 11	SDC10-3
	HLE10-OPO	350 5075	60 16	SDC10-3S
	CP701-4	210 3000	75 20	CP12-3S
	CP702-4	210 3000	114 30	SDC16-3S
 Logic Element, Normally Open, Pilot to Open	CP703-4	210 3000	200 53	CP20-3S
	CP700-3	210 3000	40 11	SDC10-3
	CP701-3	210 3000	80 21	CP12-3S
 Logic Element, Normally Open, Vent to Close	CP702-3	210 3000	115 30	SDC16-3S
	CP310-4	210 3000	40 11	SDC10-4
 Pressure Compensator, Flow Control, Priority	CP311-4	210 3000	60 16	CP12-4
	CP312-4	210 3000	130 34	CP16-4
	CP313-4	210 3000	340 90	SDC20-4
 Pressure Compensator, Flow Control, Restrictive	CP300-4	210 3000	40 11	SDC10-3
	CP301-4	210 3000	90 24	CP12-3
	CP302-4	210 3000	130 34	SDC16-3
	CP303-4	210 3045	284 754	SDC20-3
 Pressure Compensator, Load Sense, Priority, Static	CP310-6	210 3000	40 11	SDC10-4
	PC12-LPS	210 3000	75 20	CP12-4
	CP312-6	210 3000	125 33	CP16-4
	CP313-6	210 3000	200 53	SDC20-4

**HLE10 High Pressure Logic Element**



**HLEA10 High Pressure Logic Element**



# Solenoid Valves

# Solenoid Valves (continued)

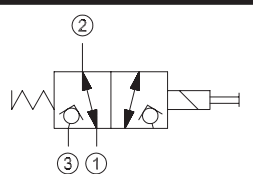
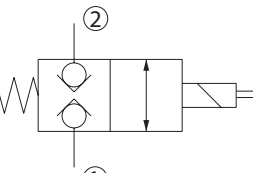
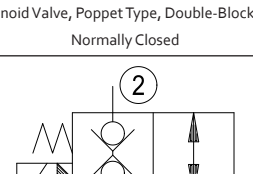
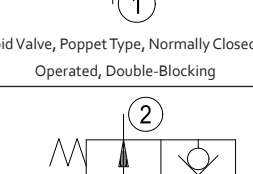
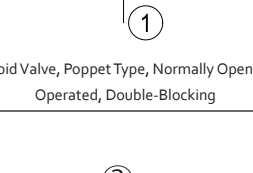
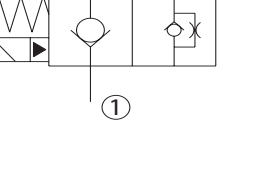
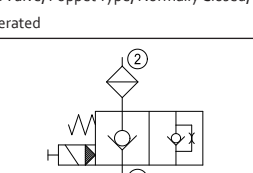
SCHEMATIC/DESCRIPTION	MODEL [FORMER]	BAR PSI	LPM GPM	CAVITY/ COIL
 Solenoid Valve, Poppet Type, 3-Way, 2-Position	EVH 06/D5	230 3300	20 5	NCS06/3 M16/R16
 Solenoid Valve, Poppet Type, Double-Blocking, Normally Closed	SVP08-CDB	230 3300	16 4	SDC08-2 M13/R13
	EVK 06/C5	210 3000	40 11	NCS06/2 M16/R13
 Solenoid Valve, Poppet Type, Normally Closed, Pilot Operated, Double-Blocking	HSVP10-CDB	<b>350</b> <b>5075</b>	60 16	SDC10-2 H16
	HSVP16-CDB	<b>350</b> <b>5075</b>	120 32	SDC16-2 H16
 Solenoid Valve, Poppet Type, Normally Open, Pilot Operated, Double-Blocking	HSVP10-ODB	<b>350</b> <b>5075</b>	60 16	SDC10-2 H16
	HSVP16-ODB	<b>350</b> <b>5075</b>	120 32	SDC16-2 H16
 Solenoid Valve, Poppet Type, Normally Closed, Pilot Operated	SVP08-NC	230 3300	35 9	SDC08-2 M13/R16
	SVP10-NC	230 3300	80 21	SDC10-2 M16/R16
	HSVP10-NC	<b>350</b> <b>5075</b>	65 17	SDC10-2 H16
	HSVP12-NC	<b>350</b> <b>5075</b>	114 30	SDC12-2CP H16
	HSVP16-NC	<b>350</b> <b>5075</b>	152 40	SDC16-2 H16
	HSVP20-NC	<b>350</b> <b>5075</b>	190 50	SDC20-2 H16
 Solenoid Valve, Poppet Type, Normally Open, Pilot Operated, Flow Control	SVP08-NCF	230 330	15 4	SDC08-2 M13/R13
 Solenoid Valve, Poppet Type, Normally Closed, Pilot Operated with Reverse Free Flow	SVP08-NCR	230 3300	35 9	SDC08-2 M13/R13
	SVP10-NCR	230 3300	80 21	SDC10-2 M16/R16
	HSVP10-NCR	<b>350</b> <b>5075</b>	65 17	SDC10-2 H16
	HSVP12-NCR	<b>350</b> <b>5075</b>	114 30	SDC12-2CP H16
	HSVP16-NCR	<b>350</b> <b>5075</b>	152 40	SDC16-2 H16
	HSVP20-NCR	<b>350</b> <b>5075</b>	190 50	SDC20-2 H16

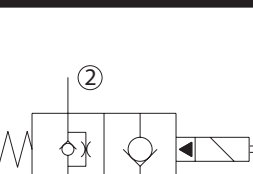
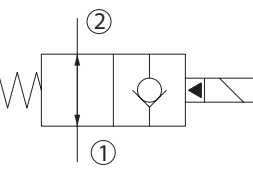
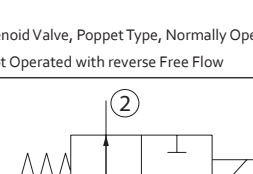
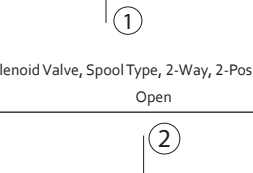
SCHEMATIC/DESCRIPTION	MODEL [FORMER]	BAR PSI	LPM GPM	CAVITY/ COIL
 Solenoid Valve, Poppet Type, Normally Open, Pilot Operated	SVP08-NO	230 3300	35 9	SDC08-2 M13/R13
	SVP10-NO	230 3300	80 21	SDC10-2 M16/R16
	HSVP10-NO	<b>350</b> <b>5075</b>	65 17	SDC10-2 H16
	HSVP12-NO	<b>350</b> <b>5075</b>	114 30	SDC12-2CP H16
	HSVP16-NO	<b>350</b> <b>5075</b>	152 40	SDC16-2 H16
	HSVP20-NO	<b>350</b> <b>5075</b>	190 50	SDC20-2 H16
 Solenoid Valve, Poppet Type, Normally Open, Pilot Operated with reverse Free Flow	SVP08-NOR	230 3300	35 9	SDC08-2 M13/R13
	SVP10-NOR	230 3300	80 21	SDC10-2 M16/R16
	HSVP10-NOR	<b>350</b> <b>5075</b>	65 17	SDC10-2 H16
	HSVP12-NOR	<b>350</b> <b>5075</b>	114 30	SDC12-2CP H16
	HSVP16-NOR	<b>350</b> <b>5075</b>	152 40	SDC16-2 H16
	HSVP20-NOR	<b>350</b> <b>5075</b>	190 50	SDC20-2 H16
 Solenoid Valve, Spool Type, 2-Way, 2-Pos., Normally Open	SV08-22-01	230 3300	16 4	SDC08-2 M13/R13
	HSV10-22-01	<b>350</b> <b>5075</b>	50 13	SDC10-2 H16
 Solenoid Valve, Spool Type, 2-Way, 2-Position, Normally Open	SV10-22-01	230 3300	27 7	SDC10-2 M16/R16
	SV15-22-01 [EDH 12/NA]	210 3000	60 16	NCS12/2 M19

**HSV 10-22**

**HSVP 10**



**HSVP 12**

**HSVP 16**

**HSVP 20**

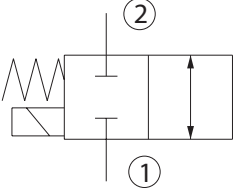
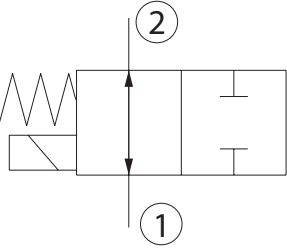
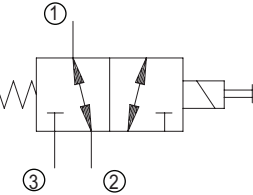
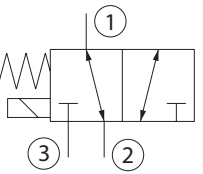
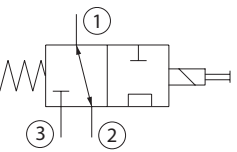
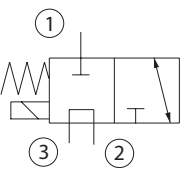

# Solenoid Valves (continued)

SCHEMATIC/DESCRIPTION	MODEL [FORMER]	BAR PSI	LPM GPM	CAVITY/ COIL
 <p>Solenoid Valve, Spool Type, 2-Way, 2-Position, Normally Closed</p>	SV08-22-02	230 3300	14 4	SDC08-2 M13/R13
	SV10-22-02	230 3300	35 9	SDC10-2 M16/R16
	<b>NEW!</b> HSV10-22-02	<b>350</b> <b>5075</b>	50 13	SDC10-2 H16
	SV15-22-02 [EDH 12/NC]	210 3000	60 6	NCS12/2 M19
 <p>Solenoid Valve, Spool Type, 2-Way, 2-Position, Normally Open</p>	SV08-22-03	230 3300	12 3	SDC08-2 M13/R13
 <p>Solenoid Valve, Spool Type, 3-Way, 2-Position</p>	SV08-23-01	230 3300	17 5	SDC08-3 M13/R13
	SV10-23-01	230 3300	28 7	SDC10-3 M16/R16
	<b>NEW!</b> HSV10-23-01	<b>350</b> <b>5075</b>	30 8	SDC10-3 H16
	CP521-21	240 3500	60 16	CP12-3 D14E
 <p>Solenoid Valve, Spool Type, 3-Way, 2-Position</p>	SV08-23-02	230 3300	10 3	SDC08-3 M13/R13
	SV09-23-02	100 1450	21 6	SDC10-3 M13/R13
	<b>NEW!</b> HSV10-23-02	<b>350</b> <b>5075</b>	28 7.4	SDC10-3 H16
	SV10-23-02	230 3300	15 4	SDC10-3 M16/R16
 <p>Solenoid Valve, Spool Type, 3-Way, 2-Position</p>	SV08-23-03	230 3300	18 5	SDC08-3 M13/R13
 <p>Solenoid Valve, Spool Type, 3-Way, 2-Position</p>	SV08-23-04	230 3300	10 3	SDC08-3 M13/R13
	SV10-23-04	230 3300	20 5	SDC10-3 M16/R16
	SV15-23-04 [EDH 12/3201]	210 3000	50 13	NCS12/3 M19

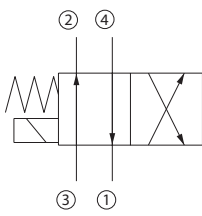
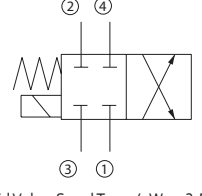
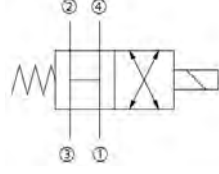
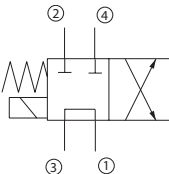
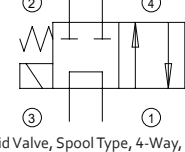
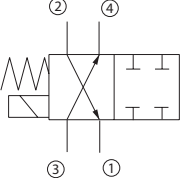
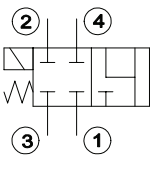
SCHEMATIC/DESCRIPTION	MODEL [FORMER]	BAR PSI	LPM GPM	CAVITY/ COIL
 <p>Solenoid Valve, Spool Type, 4-Way, 2-Position</p>	SV08-24-01	230 3300	8 2	SDC08-4 M13/R13
	SV09-24-01	<b>100</b> <b>1450</b>	20 5	SDC10-4 M13/R13
	SV10-24-01	230 3300	15 4	SDC10-4 M16/R16
	<b>NEW!</b> HSV10-24-01	<b>350</b> <b>5075</b>	25 6.6	SDC10-4 H16
 <p>Solenoid Valve, Spool Type, 4-Way, 2-Position</p>	SV15-24-01 [EDH 12/4205]	210 3000	55 15	NCS12/4 M19
	SV08-24-02	230 3300	10 3	SDC08-4 M13/R13
	SV10-24-02	230 3300	24 6.3	SDC10-4 M16/R16
 <p>Solenoid Valve, Spool Type, 4-Way, 2-Position</p>	SV15-24-02 [EDH 12/4206]	210 3000	60 16	NCS12/4 M19
	SV15-24-03 [EDH 12/4207]	210 3000	50 13	NCS12/4 M19
 <p>Solenoid Valve, Spool Type, 4-Way, 2-Position</p>	SV08-24-04	230 3300	8 2	SDC08-4 M13/R13
	SV15-24-04 [EDH 12/4208]	210 3000	50 13	NCS12/4 M19
 <p>Solenoid Valve, Spool Type, 4-Way, 2-Position</p>	SV10-24-12	230 3300	18 5	SDC10-4 M16/R16
 <p>Solenoid Valve, Spool Type, 4-Way, 2-Position</p>	SV10-24-05	230 3300	25 7	SDC10-4 M16/R16
 <p>Solenoid Valve, Spool Type, 4-Way, 2-Position</p>	SV10-24-06	230 3300	20 5	SDC10-4 M16/R16

# Solenoid Valves - (continued)

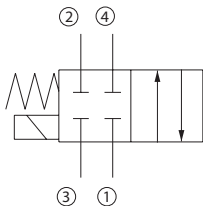
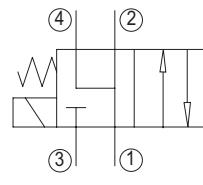
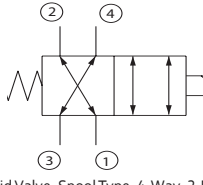
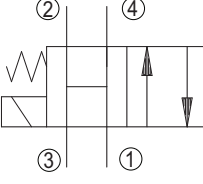
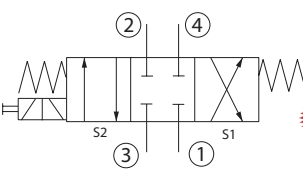
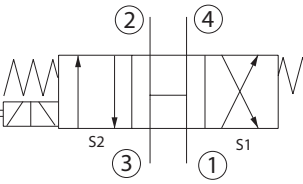
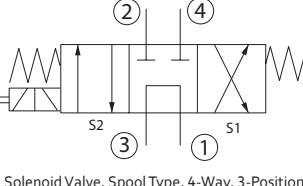
SCHEMATIC/DESCRIPTION	MODEL [FORMER]	BAR PSI	LPM GPM	CAVITY/ COIL
 Solenoid Valve, Spool Type, 4-Way, 2-Position	SV10-24-07	230 3300	24 6	SDC10-4 M16/R16
 Solenoid Valve, Spool Type, 4-Way, 2-Position	SV08-24-08	230 3300	24 6	SDC08-4 M13/R13
 Solenoid Valve, Spool Type, 4-Way, 2-Position	CP531-21	240 3500	32 8	CP12-4 D14E
 Solenoid Valve, Spool Type, 4-Way, 2-Position	SV10-24-13	230 3300	21 6	SDC10-4 M16/R16
 Solenoid Valve, Spool Type, 4-Way, 3-Position	SV08-34-02	230 3300	10 4	SDC08-4 M13/R13
	SV10-34-02	230 3300	20 6	SDC10-4 M16/R16
	<b>NEW!</b> HSV10-34-02	350 5075	25 6.6	SDC10-4 H16
	SV15-34-02 [EDH 12/4306]	210 3000	55 15	NCS12/4 M19
 Solenoid Valve, Spool Type, 4-Way, 3-Position	SV08-34-03	230 3300	8 2	SDC08-4 M13/R13
	SV10-34-03	230 3300	16 4	SDC10-4 M16/R16
	SV15-34-03 [EDH 12/4307]	210 3000	50 13	NCS12/4 M19
 Solenoid Valve, Spool Type, 4-Way, 3-Position	SV08-34-04	230 3300	6 2	SDC08-4 M13/R13
	SV15-34-04 [EDH 12/4308]	210 3000	50 13	NCS12/4 M19

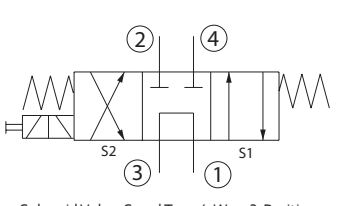
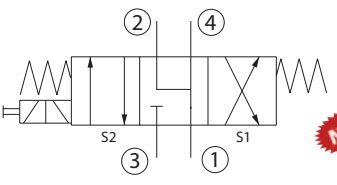
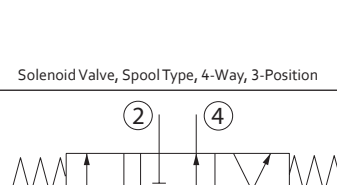
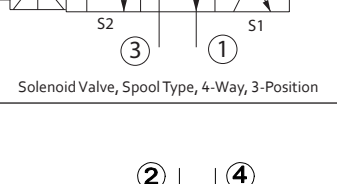
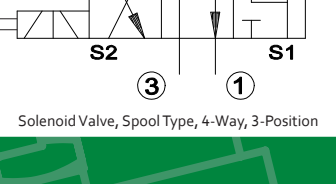
SCHEMATIC/DESCRIPTION	MODEL [FORMER]	BAR PSI	LPM GPM	CAVITY/ COIL
 Solenoid Valve, Spool Type, 4-Way, 3-Position	SV10-34-04	230 3300	15 4	SDC10-4 M16/R16
 Solenoid Valve, Spool Type, 4-Way, 3-Position	SV08-34-05	230 3300	10 3	SDC08-4 M13/R13
	SV10-34-05	230 3300	20 5	SDC10-4 M16/R16
	<b>NEW!</b> HSV10-34-05	350 5075	25 6.6	SDC10-4 H16
 Solenoid Valve, Spool Type, 4-Way, 3-Position	SV15-34-05 [EDH 12/4309]	210 3000	55 15	NCS12/4 M19
 Solenoid Valve, Spool Type, 4-Way, 3-Position	SV10-34-11	230 3300	24 6	SDC10-4 M16/R16
 Solenoid Valve, Spool Type, 4-Way, 3-Position	SV10-34-14	230 3300	18 5	SDC10-4 M16/R16

**HSV 10-23**



**HSV 10-24**



**HSV 10-34**



**NEW!**



**Push-and-Twist  
Manual Override**

**2Q 14**



**Push-Pull  
Manual Override**

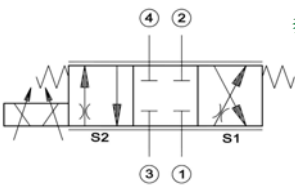
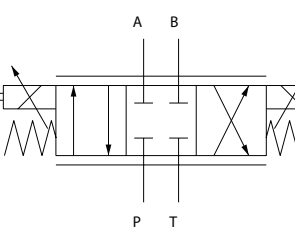
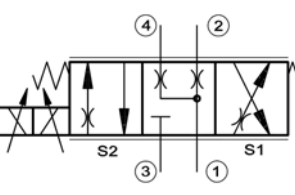
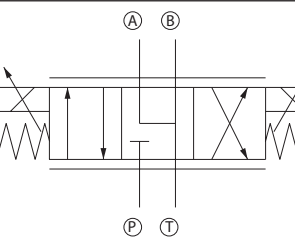

## Proportional Valves - Directional

SCHEMATIC/DESCRIPTION	MODEL [FORMER]	BAR PSI	LPM GPM	CAVITY/ COIL
 <p>Proportional Directional Valve, Closed Center</p>	PSV08-34-02	210 3045	11 3	SDC08-4 M13/R13
	PSV10-34-02	250 3600	22 6	SDC10-4 M16/R16
	PSV12-34-02	250 3600	50 13	CP12-4 M19
 <p>Proportional Directional Valve, Cetop</p>	PDCV03-3Z11	350 5000	30.3 8	ISO D05 PD03
	PDCV05-3Z11	350 5000	60 16	ISO D003 PD03
 <p>Proportional Directional Valve, Float Center</p>	PSV08-34-05	210 3045	130 34	SDC08-4 M13/R13
	PSV10-34-05	250 3600	22 6	SDC10-4 M16/R16
	PSV12-34-05	250 3600	60 16	CP12-4 M19
 <p>Proportional Directional Valve, Cetop</p>	PDCV03-3Y11	320 4640	30.3 8	ISO D03 PD03
	PDCV05-3Y11	320 4600	60 16	ISO D05 PD05

## Proportional Valves - Flow Control

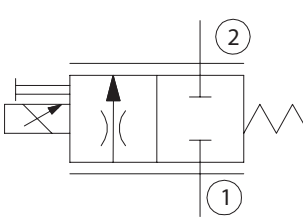
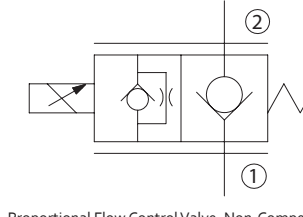
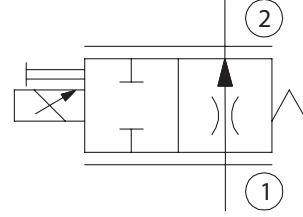
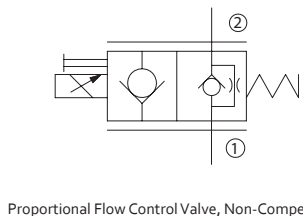
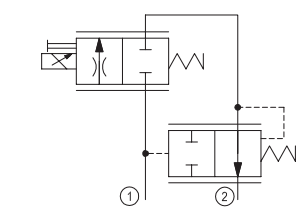
SCHEMATIC/DESCRIPTION	MODEL [FORMER]	BAR PSI	LPM GPM	CAVITY/ COIL
 <p>Proportional Flow Control Valve, Non-Compensated, Normally Open</p>	CP518-PNC	210 3000	12 3	SDC08-2 M19P
	PSV10-NC	260 3770	40 11	SDC10-2 M19P
	PSV12-NC	260 3770	80 21	SDC12-2 D14E (35W)
	PSV16-NC	260 3770	100 26	SDC16-2 D14E (35W)
 <p>Proportional Flow Control Valve, Non-Compensated, Normally Closed, Poppet Type</p>	PSVP10-NCR	260 3770	55 14	SDC10-2 M19P
	PSVP12-NCR	260 3770	70 18	SDC12-2 M19P
 <p>Proportional Flow Control Valve, Non-Compensated, Normally Open</p>	CP518-PNO	210 3000	12 3	SDC08-2 M19P
	PSV10-NO	260 3770	45 12	SDC10-2 M19P
	PSV12-NO	260 3770	100 26	SDC12-2 D14E (35W)
 <p>Proportional Flow Control Valve, Non-Compensated, Normally Open, Poppet Type</p>	PSVP10-NOR	260 3770	45 12	SDC10-2 M19P
	PSVP12-NOR	260 3770	70 18	SDC12-2 M19P
	PSVP16-NOR	260 3770	90 24	SDC16-2 M19P
 <p>Proportional Flow Control Valve, Pressure Compensated, Restrictive Type, Normally Closed</p>	PFC10-RC	260 3770	30 8	SDC10-2 M19P
	PFC12-RC	260 3770	65 17	SDC12-2 D14E (35W)
	PFC16-RC	260 3770	90 24	SDC16-2 D14E (35W)

**PSV 10-34  
w/Robust Coils**



**PSV 12-34**

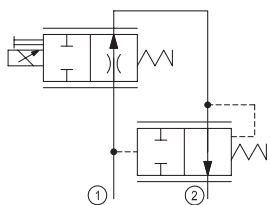
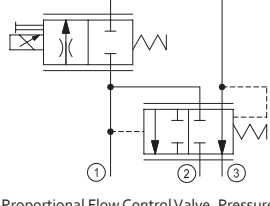
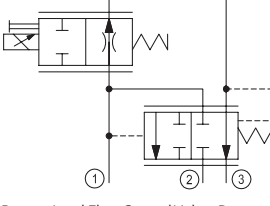
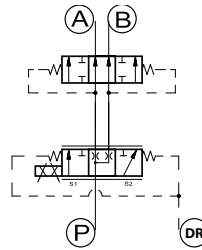

## Proportional Valves - Flow Control continued)

SCHEMATIC/DESCRIPTION	MODEL [FORMER]	BAR PSI	LPM GPM	CAVITY/ COIL
 <p>Proportional Flow Control Valve, Pressure Compensated, Restrictive Type, Normally Open</p>	PFC10-RO	260 3770	30 8	SDC10-2 M19P
	PFC12-RO	260 3770	60 16	SDC12-2 D14E (35W)
	PFC16-RO	260 3770	85 22	SDC16-2 D14E (35W)
 <p>Proportional Flow Control Valve, Pressure Compensated, Priority Type, Normally Closed</p>	PFC10-PC	260 3770	40 11	SDC10-3 M19P
	PFC12-PC	260 3770	65 17	SDC12-3 D14E (35W)
	PFC16-PC	260 3770	85 22	SDC16-3 D14E (35W)
 <p>Proportional Flow Control Valve, Pressure Compensated, Priority Type, Normally Open</p>	PFC10-PO	260 3770	35 9	SDC10-3 M19P
	PFC12-PO	260 3770	70 18	SDC12-2 D14E (35W)
	PFC16-PO	260 3770	85 22	SDC16-3 D14E (35W)
 <p>Proportional Flow Divider, Compensated, Catalog HIC</p>	PFD10-OD	230 3335	40 11	#4 & #6 SAE Ports 3/8 & 1/2 BSP M16

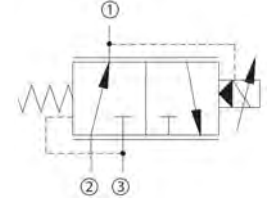
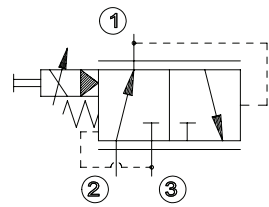
SCHEMATIC/DESCRIPTION	MODEL [FORMER]	BAR PSI	LPM GPM	CAVITY/ COIL
 <p>Proportional Pressure Red/Relieving Valve, Piloted, Normally Closed</p>	PPR10-PAC	250 3625	18 5	SDC10-3 M19P
 <p>Proportional Pressure Red/Relieving Valve, Piloted, Normally Open</p>	XRP 06	315 4500	25 7	NCS06/3 M19P

## Proportional Flow Control Valves

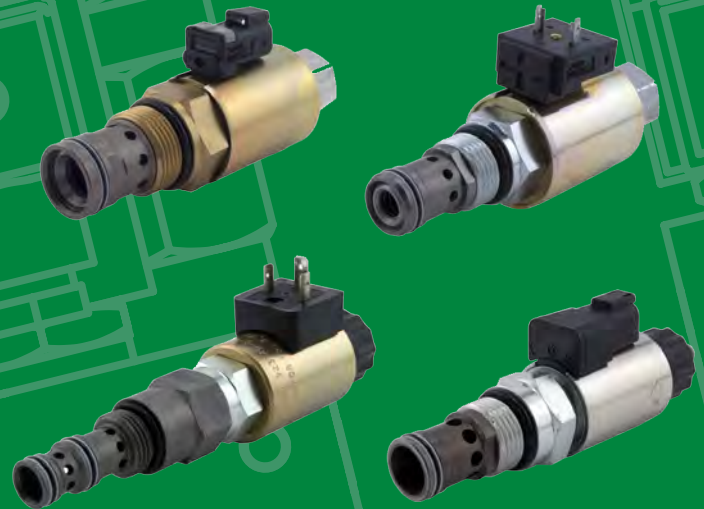

## Proportional Valves - Pressure Reducing

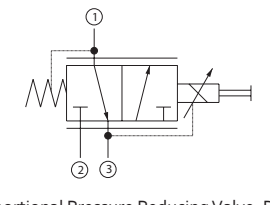
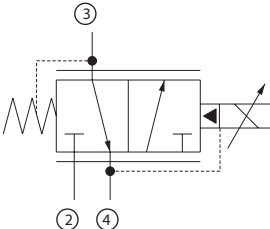
SCHEMATIC/DESCRIPTION	MODEL	BAR PSI	LPM GPM	CAVITY/ COIL
 <p>Proportional Pressure Reducing Valve, Direct Acting, Norm. Open</p>	CP558-24	34 500	4 1	SDC08-3 D08
 <p>Proportional Pressure Red/Relieving, Pilot Operated, Normal Open to Drain</p>	PPR09-POD [XRP 044]	50 700	25 7	SDC10-4 M13/R13

## PPR09-POD

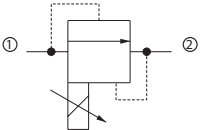
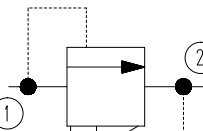
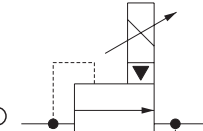
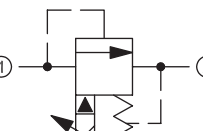

# Proportional Valves - Pressure Relieving

SCHEMATIC/DESCRIPTION	MODEL	BAR PSI	LPM GPM	CAVITY/ COIL
 Proportional Pressure Relief Valve, Direct Acting, Norm. Open	XMD 04	250 3600	5 1	NCS04/2 M19P
	CP558-20	210 300	8 2	SDC08-2 D10
 Proportional Pressure Relieving Valve, Direct Acting, Normally Closed	2Q 14 PRV08-DAC	210 3045	2.1 0.55	SDC08-2 M13/R13
	2Q 14 HPRV08-DAC	350 5075	1.2 0.32	SDC08-2 M13/R13
 Proportional Relief Valve, Pilot Operated, Normally Closed	PRV10-POC	250 3600	76 20	SDC10-2 M19P
	PRV12-POC	250 3600	180 48	SDC12-2 M19P
 Proportional Relief Valve, Pilot Operated, Normally Open	XMP 06	315 4500	50 13	NCS06/2 M19P

HPRV08-DAC & PRV08-DAC

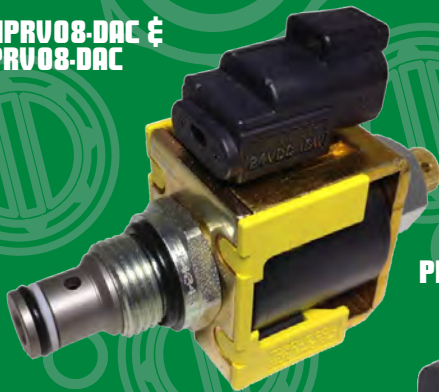

PRV10-POC

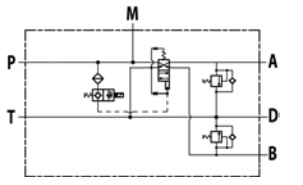
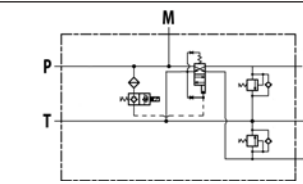
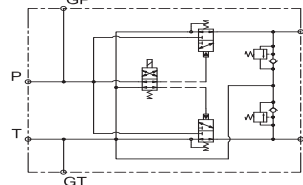
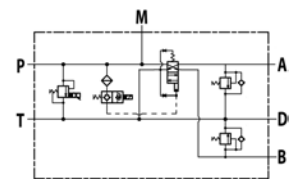
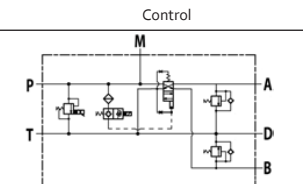
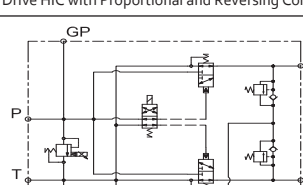

# Fan Drive HICs

 Fan Drive HIC with Reversing Control	NEW! RFDE-40-000	210 3000	10 to 40 (2.6 to 10.5)	#12 SAE 3/4 BSP
 Fan Drive HIC with Reversing Control	NEW! RFDE-80-000	210 3000	20 to 80 (5.3 to 21.1)	#12 SAE 3/4 BSP
 Fan Drive HIC with Reversing Control	RFD-120-000	210 3000	120 (31.7)	#12 SAE 3/4 BSP
 Fan Drive HIC with Proportional and Reversing Control	NEW! RFDE-40-PRV	210 3000	10 to 40 (2.6 to 10.5)	#12 SAE 3/4 BSP
 Fan Drive HIC with Proportional and Reversing Control	NEW! RFDE-80-PRV	210 3000	20 to 80 (5.3 to 21.1)	#12 SAE 3/4 BSP
 Fan Drive HIC with Proportional and Reversing Control	RFD-120-PRV	210 3000	120 (31.7)	#12 SAE 3/4 BSP

RFDE

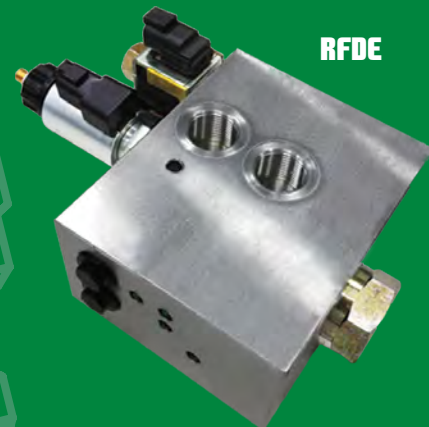

# Motor Mount HICs

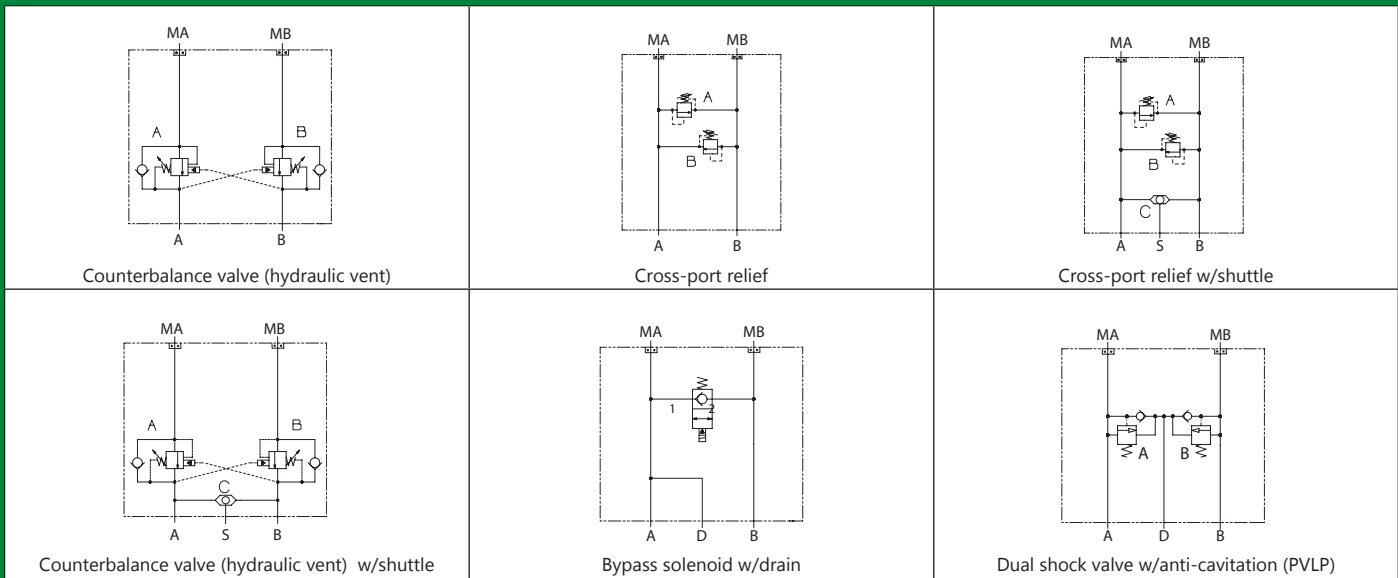

Danfoss Motor	DH	DS	OMP/OMR	OMH	OMS	OMT
<b>Maximum continuous flow l/min [US gal/min]</b>	60 [16]	60 [16]	60 [16]	75 [20]	75 [20]	125 [33]
<b>Counterbalance valve (hydraulic vent)</b>	MM-DH-00-DCB10-HV	MM-DS-00-DCB10-HV	MM-OMP/OMR-00-DCB10-HV	MM-OMH-00-DCP441-1	MM-OMS-00-DCP441-1	MM-OMT-00-DCP441-1
<b>Counterbalance valve (hydraulic vent) w/shuttle</b>	MM-DH-LS-DCB10-HV	MM-DS-LS-DCB10-HV	MM-OMP/OMR-LS-DCB10-HV	MM-OMH-LS-DCP441-1	MM-OMS-LS-DCP441-1	MM-OMT-LS-DCP441-1
<b>Cross-port relief</b>	MM-DH-00-DVME06	MM-DS-00-DVME06	MM-OMP/OMR-00-DVME06	MM-OMH-00-DCP211-2	MM-OMS-00-DCP211-2	MM-OMT-00-DCP211-2
<b>Cross-port relief w/shuttle</b>	MM-DH-LS-DVME06	MM-DS-LS-DVME06	MM-OMP/OMR-LS-DVME06	MM-OMH-LS-DCP211-2	MM-OMS-LS-DCP211-2	MM-OMT-LS-DCP211-2
<b>Bypass solenoid w/drain</b>	MM-DH-00-BSVP10-NCR	MM-DS-00-BSVP10-NCR	MM-OMP/OMR-00-BSVP10-NCR	MM-OMH-00-BSVP10-NCR	MM-OMS-00-BSVP10NCR	MM-OMT-00-BCP502-3
<b>Dual shock valve w/anti-cavitation (PVLP)</b>	MM-DH-00-DPVLP	MM-DS-00-DPVLP	MM-OMP/OMR-00-DPVLP	MM-OMH-00-DPVLP	MM-OMS-00-DPVLP	MM-OMT-00-DPVLP

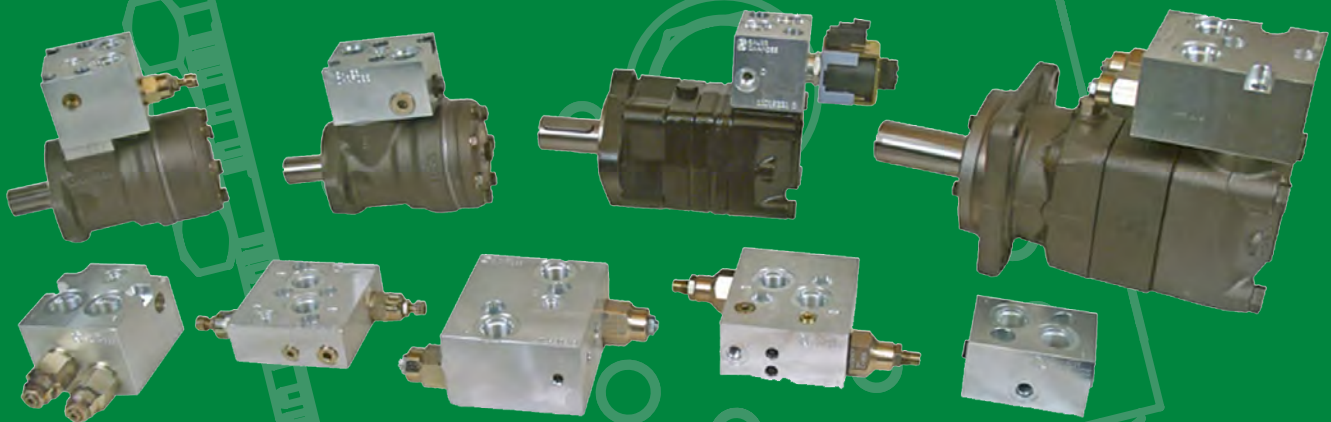

# Traction Controls

SCHEMATIC/DESCRIPTION	MODEL	DESCRIPTION	BAR PSI	DISPLACEMENT	PORTS
	X05-FD10	Traction Control - for hydrostatic systems with one pump and two motors in parallel. Designed to prevent wheel spin or motor overspeed	210 3045	45 LPM 12 GPM	1/2 & 3/4 BSP #8 & #12 SAE
	X05-FD16	Traction Control - for hydrostatic systems with one pump and two motors in parallel. Designed to prevent wheel spin or motor overspeed	210 3045	150 LPM 40 GPM	1 & 1 1/4 BSP #16 & #20 SAE 1" Code 61
	X05-FD104	Traction Control - for hydrostatic systems with one pump and four motors in parallel. Designed to prevent wheel spin or motor overspeed	230 3335	45 LPM 12 GPM	#8 & #10 SAE

# Accessories

SCHEMATIC/DESCRIPTION	MODEL/CAVITY	BAR PSI	DISPLACEMENT
 Cavity Plug Filter	CPF20-3 SDC20-3	210 3000	20 & 30 Micro Filter
	CP600-5 SDC10-2	210 3000	1.2 cc / stroke 0.07 ci / stroke
	CP602-5 SDC16-2	210 3000	9.2 cc / stroke 0.56 ci / stroke
	MP 06 NCS06/2	210 3000	0.94 cc / stroke 0.057 ci / stroke
	MP 12 NCS 12/2	315 4500	5cc / stroke 0.305 ci /stroke

# Spreader Valves

SCHEMATIC/DESCRIPTION	MODEL/CAVITY	BAR PSI	LPM GPM
 Spreader Valve, Dual Flow Regulation, Compensated, Manual Dump, Gear Pump Circuit	SPR-2FFL12	138 2000	114 30
 Spreader Valve, Dual Flow Regulation, Compensated, Manual Dump, Piston Pump Circuit	SPR-2FFLC12	210 3000	114 30
 Spreader Valve, Spreader Valve, Dual Flow Regulation, Compensated, Solenoid Dump, Gear Pump Circuit	SPR-2FFLW86	138 2000	114 30

## Mix - N - Match Dual Bodies

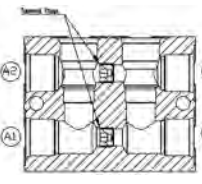
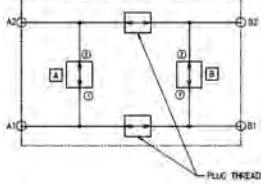
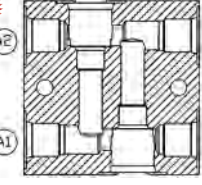
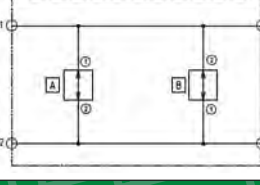
Cross Section (Example)	Schematic	Nomenclature	Cavity	Ports
 <p>Dual Parallel Body</p>		DPL08-2	SDC08-2	#6 SAE, 3/8 BSP
		DPL10-2	SDC10-2	#8 SAE, 1/2 BSP
		DPL12-2	SDC12-2CP	#12 SAE, 3/4 BSP
		DPL16-2	SDC16-2	#16 SAE, 1 BSP
 <p>Dual Cross-Port Body</p>		DCP08-2	SDC08-2	#6 SAE, 3/8 BSP
		DCP10-2	SDC10-2	#8 SAE, 1/2 BSP
		DCP12-2	SDC12-2CP	#12 SAE, 3/4 BSP
		DCP16-2	SDC16-2	#16 SAE, 1 BSP

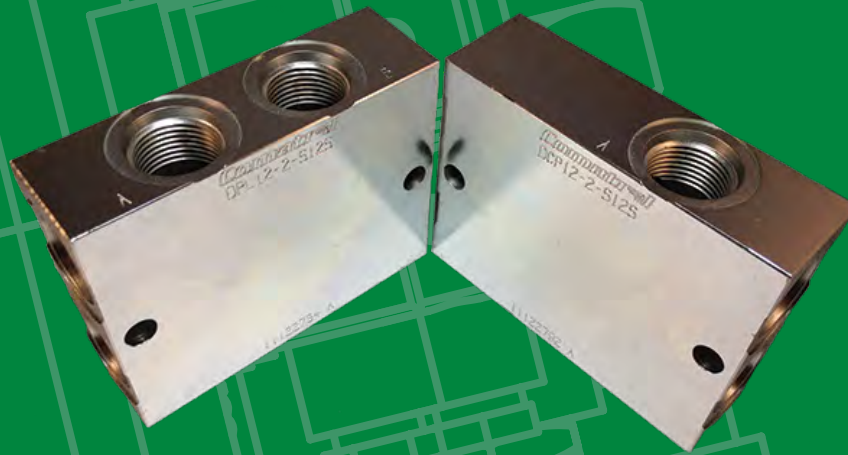

## DCV03 & DCV05 Valves

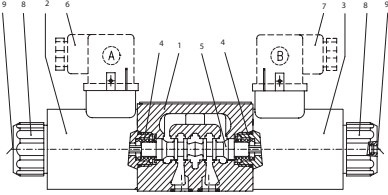
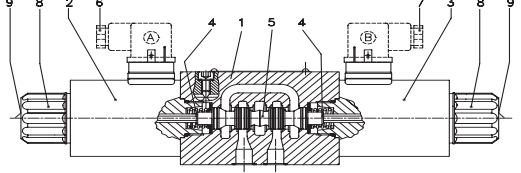
DCV03	DCV05
	
<p>Various 4W 3P &amp; 4P Schematics. Sub-plate mounting pattern in line with NFPA D03 (CETOP 3, NG 6) standards. Mounting Pattern: ISO D03</p>	<p>Various 4W 3P &amp; 4P Schematics. Sub-plate mounting pattern in line with NFPA D05 (CETOP 5, NG 10) standards. Mounting Pattern: ISO D05</p>

Many Comatrol cavities are designed around SAE standard O-ring thread ports. In many cases these cavities are interchangeable with cavities used by other manufacturers. The table below is intended as a guide for cartridge valve interchanges.

## Cavity Crossover Table

Comatrol	Thread	Delta Power	Eaton-Vickers	HydraForce	Parker	Sterling [Parker]	Command Controls [Bucher]	
CP04-2	7/16-20			NO	NO		NO	
CP04-3				NO	NO		NO	
CP07-3	5/8-18	YES		YES	YES			
SDC08-2	3/4-16	YES	YES	YES	YES	YES	YES	
SDC08-3		YES	YES	YES	YES	YES	YES	
CP08-3L								
SDC08-4		YES	YES	YES	YES	YES	YES	
SDC10-2	7/8-14	YES	YES	YES	YES	YES	YES	
SDC10-3		YES	YES	YES	YES	YES	YES	
SDC10-3S				YES	YES	YES	YES	YES
SDC10-4		YES	YES	YES	YES	YES	YES	YES
SDC12-2CP (old CP12-2)	1 1/16-12	NO	NO	YES	NO		NO	
SDC12-2		NO	NO	NO	NO		NO	
CP12-3S		NO	NO	NO	NO		NO	
CP12-3		NO	NO	YES	NO		NO	
CP12-4		NO	NO	NO	NO		NO	
SDC16-2	1 5/16-12		YES	YES	YES	YES	YES	
SDC16-3S				YES	YES	YES	YES	
SDC16-3				YES	YES	YES	YES	
SDC16-4				YES	YES	YES	YES	
SDC20-2	1 5/8-12		YES		YES			
CP20-3S				NO				
SDC20-3			YES					
SDC20-4			YES					

Please note that most manufacturers have many non-standard cavities and that details are subject to change. Compare cavity details before interchanging cartridges.

Coils	Valve Tube Outer Diameter	Coil Type	Wattage	Diode	10 VDC	12 VDC	20 VDC	24 VDC	110 / 220 VAC
D08	0.500 inch	Standard	16		X	X	X	X	Internally Rectified
D10	0.625 inch	Standard	16 & 30		X	X	X	X	Internally Rectified
M13	13 mm	Standard	20	Unidirectional	X	X	X	X	External Rectifier Needed
M16	16 mm	Standard	26	Unidirectional	X	X	X	X	External Rectifier Needed
M19	19 mm	Standard	33	Unidirectional		X		X	
D14E	0.875 inch	Robust	30		X	X	X	X	
D14E (35W)	0.875 inch	Robust	35			X		X	
R13	13 mm	Robust	16	Bi-directional	X	X	X	X	
R16	16 mm	Robust	20	Bi-directional	X	X	X	X	
<b>NEW!</b> H16	16mm	Robust	29	Bi-directional		X		X	
M19P	19 mm (proportional)	Robust	22			X		X	

WWW.COMATROL.COM

**Comatrol**  
 RESPONSIVENESS IN MOTION

Member of the Danfoss Group

**Catalogs Available Online and Print Edition**

Binder (includes all sections below) ..... 11141705  
 IN-Introduction ..... 11143603  
 CV-Check Valves Catalog..... 11141707  
 SH-Shuttle Valves Catalog ..... 11141709  
 RV-Relief Valves Catalog ..... 11141711  
 PR-Pressure Reducing Valves ..... 11141712  
 SQ-Sequence Valves Catalog ..... 11141713  
 FC-Flow Control Valves Catalog ..... 11141714  
 PO-Pilot Operated Check Valves Catalog... 11141715  
 CB-Counterbalance Valves Catalog..... 11141716  
 DV-Directional Control Valves Catalog ..... 11141719  
 LE-Logic Elements Catalog ..... 11141720  
 SV-Solenoid Valves Catalog ..... 11141717  
 PV-Proportional Valves Catalog ..... 11141718  
 FD-Fan Drive HICs Catalog..... 11141721  
 MM-Motor Mount HICs Catalog..... 11141722  
 TC-Traction Control HICs Catalog..... 11141723  
 SP-Spreader Valves Catalog..... 11141724  
 MX-Mix-N-Match HICs Catalog..... 11141725  
 D3-DCV03 Solenoid Valves Catalog ..... 11141726  
 D5-DCV05 Solenoid Valves Catalog ..... 11141727  
 AC-Accessories Catalog ..... 11141729  
 CA-Cavities Catalog ..... 11141730  
 HS-Housings Catalog ..... 11141731  
 CL-Coils Catalog ..... 11141732  
 CX-Cross Reference Catalog ..... 11141733  
 ID-Index..... 11141734

Comatrol, a member of the Danfoss Group, is the most responsive and innovative choice for Cartridge Valves and Hydraulic Integrated Circuit (HIC) needs. Comatrol works with customers and suppliers around the world to manufacture high performance machine control solutions for mobile, on-highway, energy and industrial equipment markets.



**Responsiveness In Motion**



**Application Know-How**



**EasyValve Drag! Drop! Deliver!**



**Rhythm of Innovation**

**Comatrol (Americas)**

1407 Pelzer Highway  
 Easley, SC 29642  
 Phone: +1 864 644-0055  
 marketing@comatrol.com

**Comatrol (Europe)**

Via Rinaldi, 111 I-42124  
 Reggio Emilia Italy  
 Phone: +39 0522 915511  
 Fax: +39 0522 915555  
 marketing@comatrol.com

**Comatrol China Sales Office**

22F, Bldg C, No 900, Yishan Rd.  
 Shanghai 200233, P.R. China  
 Phone: + 86 21 3418 5292  
 Fax: + 86 21 6495 2622  
 info-china@comatrol.com

**Comatrol China Plant**

No. 626, Rong Qiao Rd., Jin Qiao  
 EPZ, Pudong  
 Shanghai 201206, P.R. China  
 Phone: + 86 21 2035 8128  
 Fax: + 86 21 5834 5748

